

# SUNLIGHT

## Solid Wood Venetian Blinds Installation Instructions

### CONTENTS

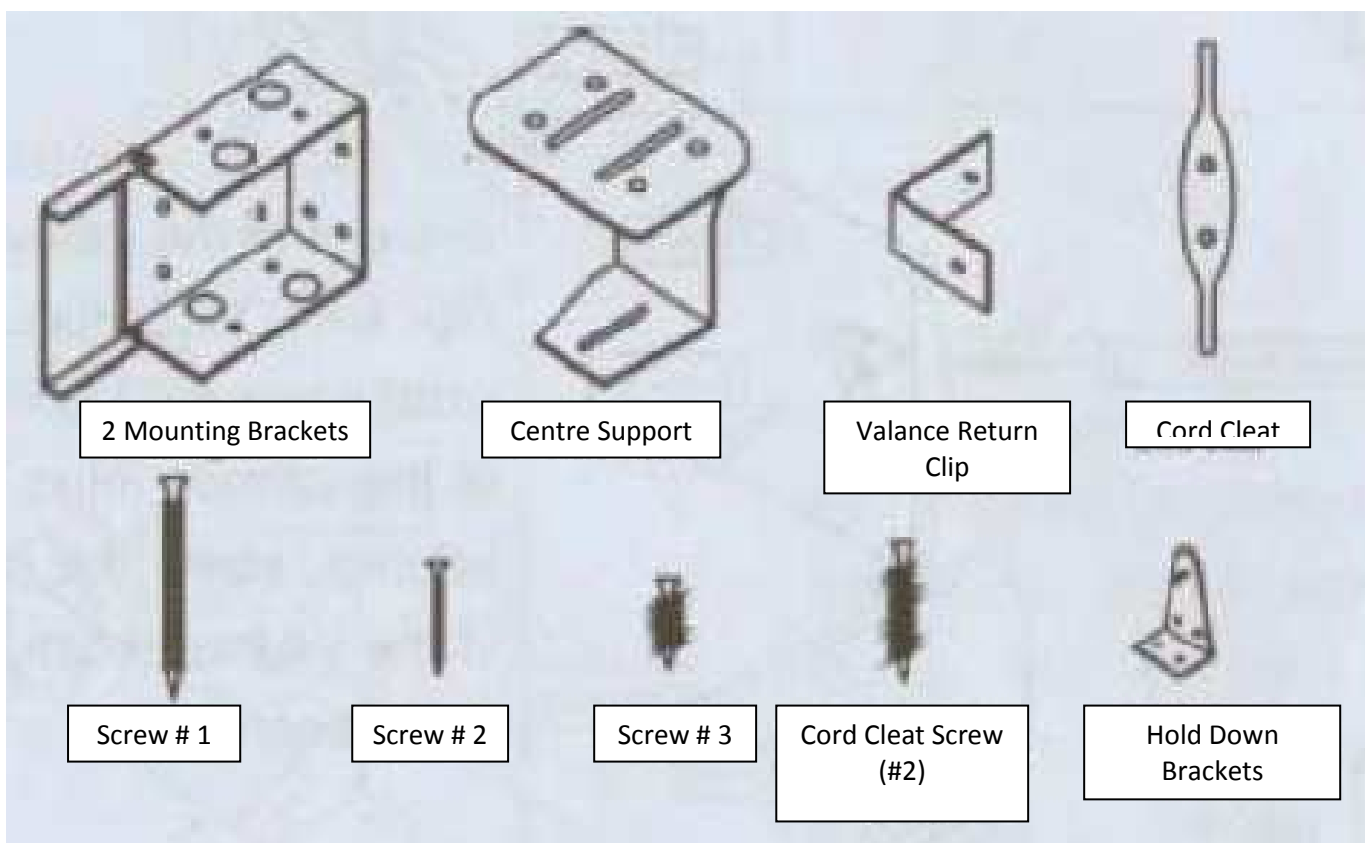

(Note: Centre support supplied for blind width 90cm or over)

## Tools Required for Installation

Tape Measure	Phillips Head Screwdriver
Marking Pencil	Step Ladder
Drill	Drill Bit (1/8" diameter)

Reduce Risk of Strangulation for Infants and Toddlers  
Position Safety Cord-Stops before Using Blinds

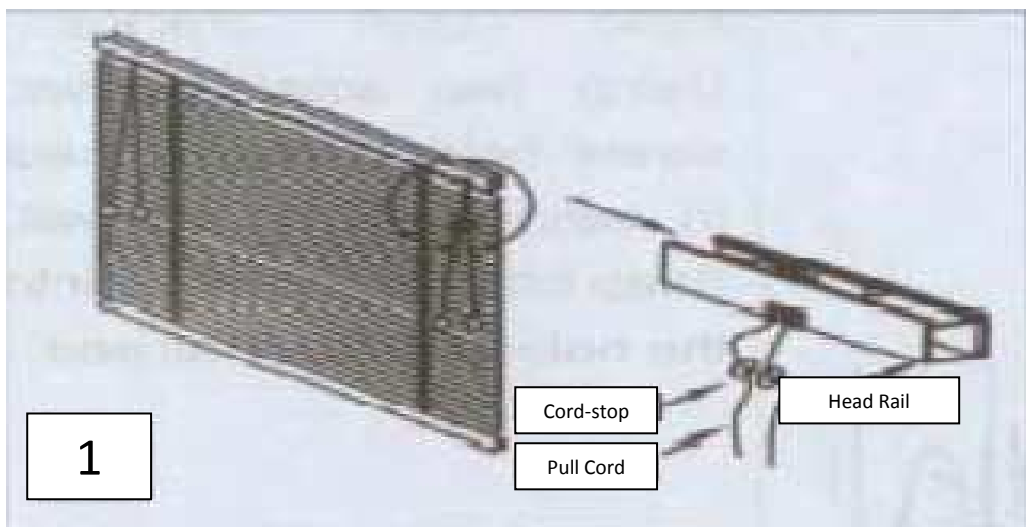

1. Measure the distance from Head Rail to cord-stops. If Cord-stops are 1 to 12 inches below the head rail, no further adjustment is needed. Your blinds are ready to use.

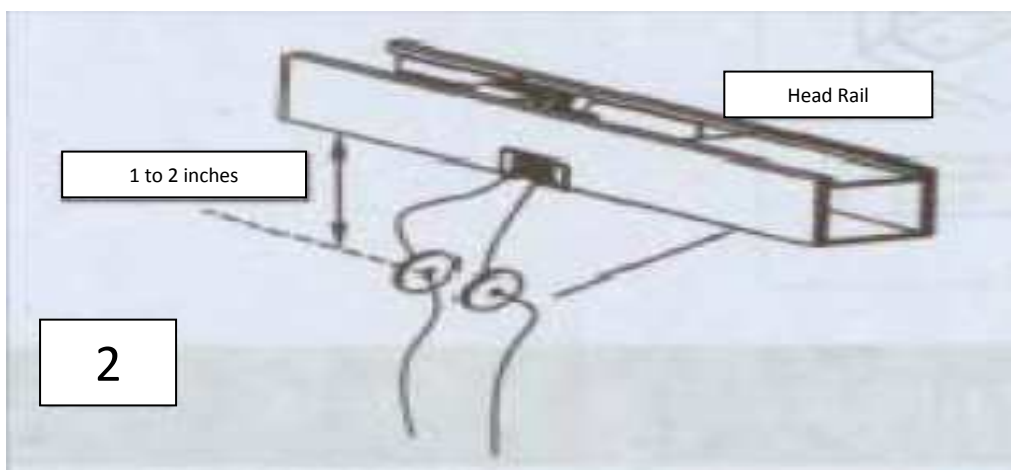

2. If cord-stops are NOT 1 or 2 inches below head rail, loose (but do not untie) the knot surrounding the cord-stop.

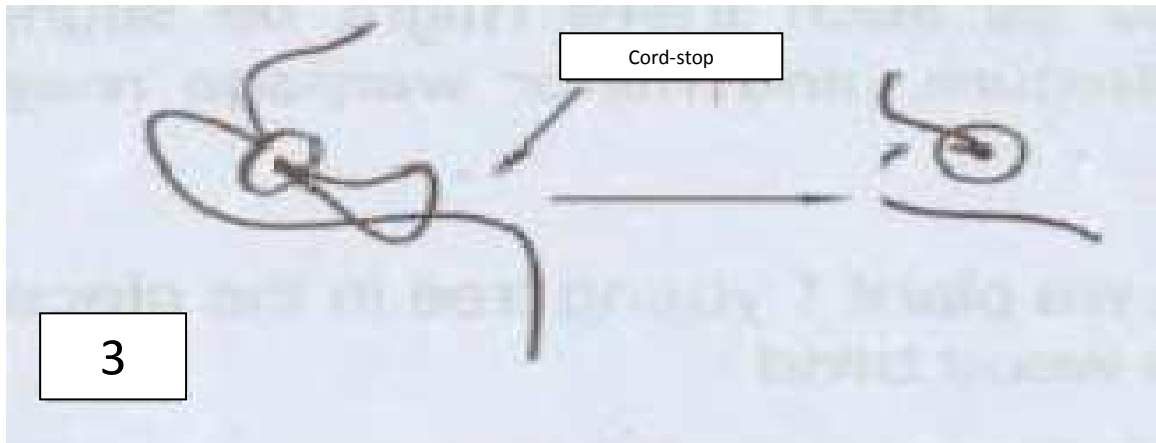

3. Push both the cord-stop and the loosened knot towards the lead rail until the cord-stop is 1 to 2 inches below the head rail. Hold cord-stop in place and pull firmly on pull cord to re-tighten knot. Repeat steps 2, 3 and 4 for each cord-stop.

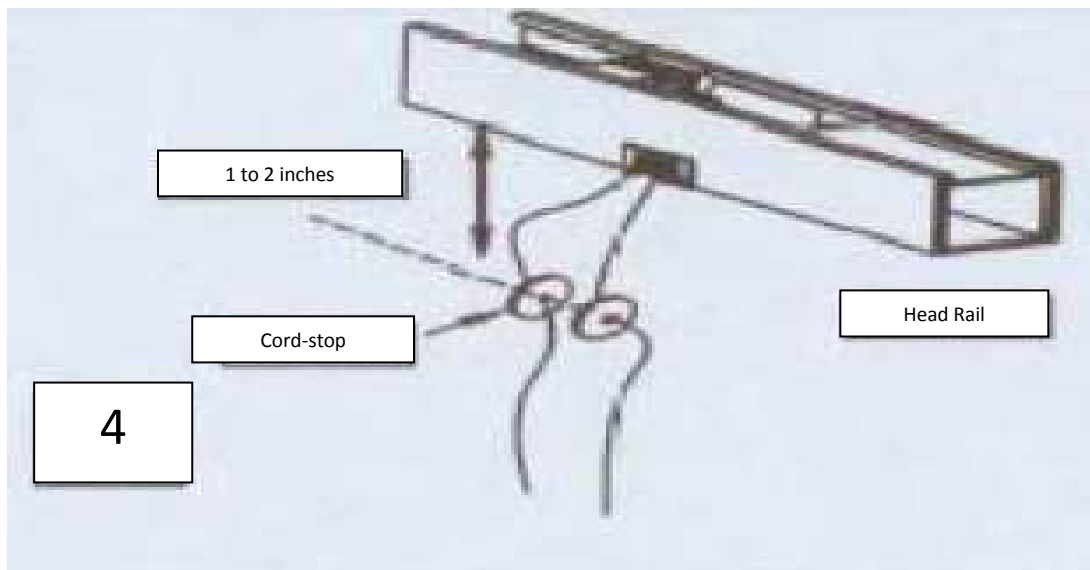

4. Push cord-stop and the loosened knot toward the head rail until the cord-stop is 1 to 2 inches below the head rail. Hold the cord-stop in place and pull firmly on the pull cord to re-tighten the knot. Repeat steps 2, 3 and 4 for each cord-stop.

NOTE: Use of Hold Down Brackets is recommended to fully utilise the safety feature of cord-stops.

## MOUNTING INSTRUCTIONS

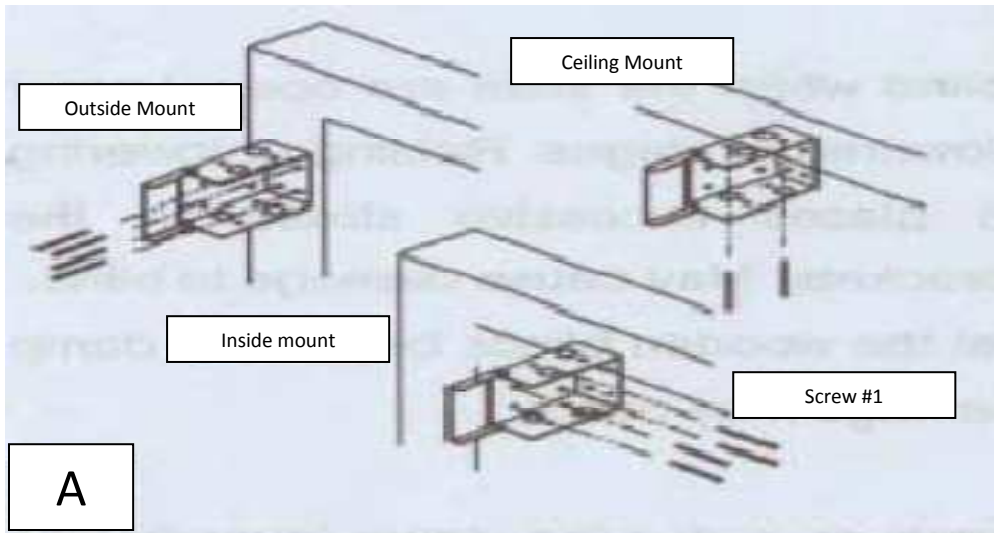

A. Brackets should be placed at the width of the blind's head rail 6mm past each end. The bracket doesn't necessarily need to touch the inside face of the window frame.

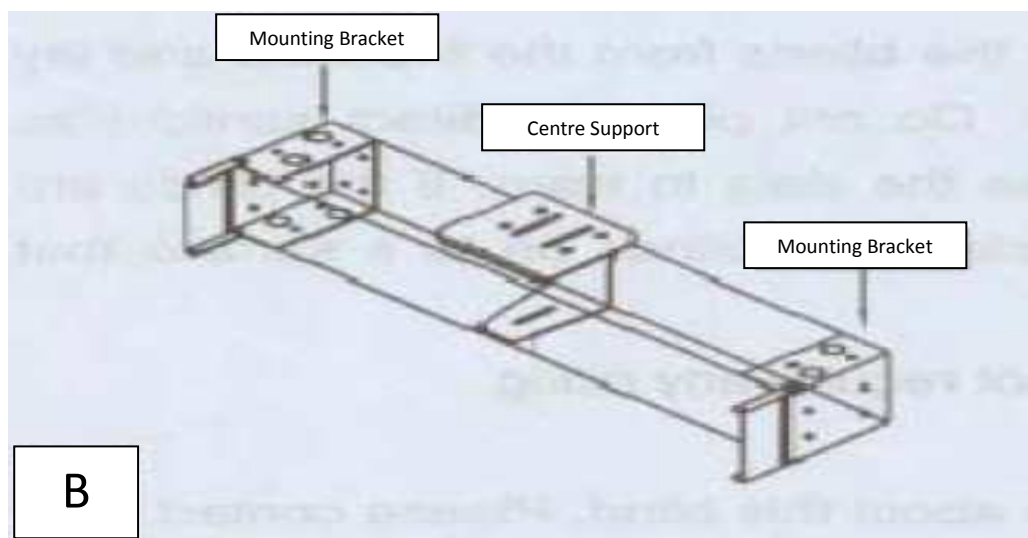

B. Align the top of the centre support bracket with the top of the mounting bracket before installation. Install with the bigger flap of the centre support bracket on the top side and clear of the slat ladder positions.

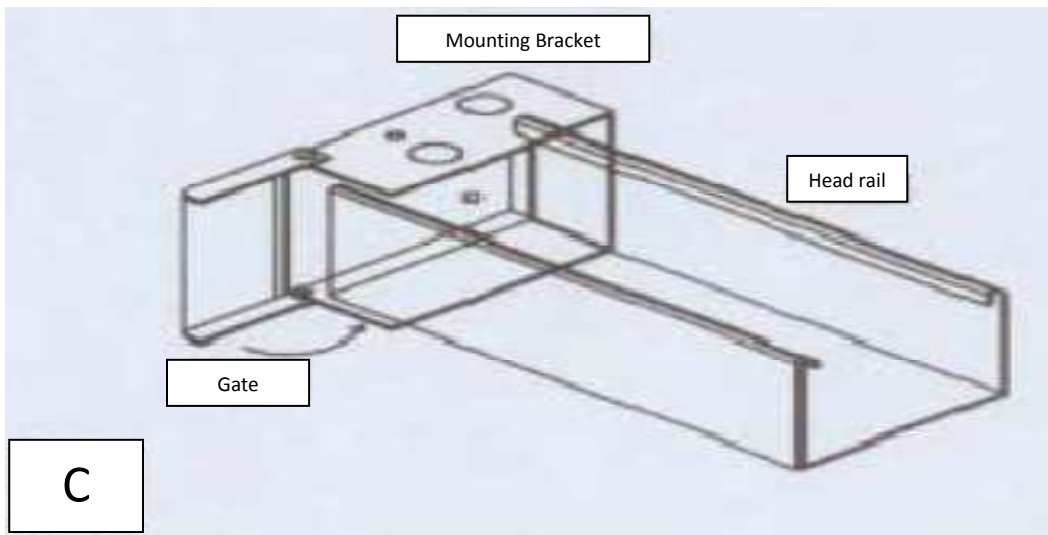

C. Push rail into brackets and then close gate to close the brackets.

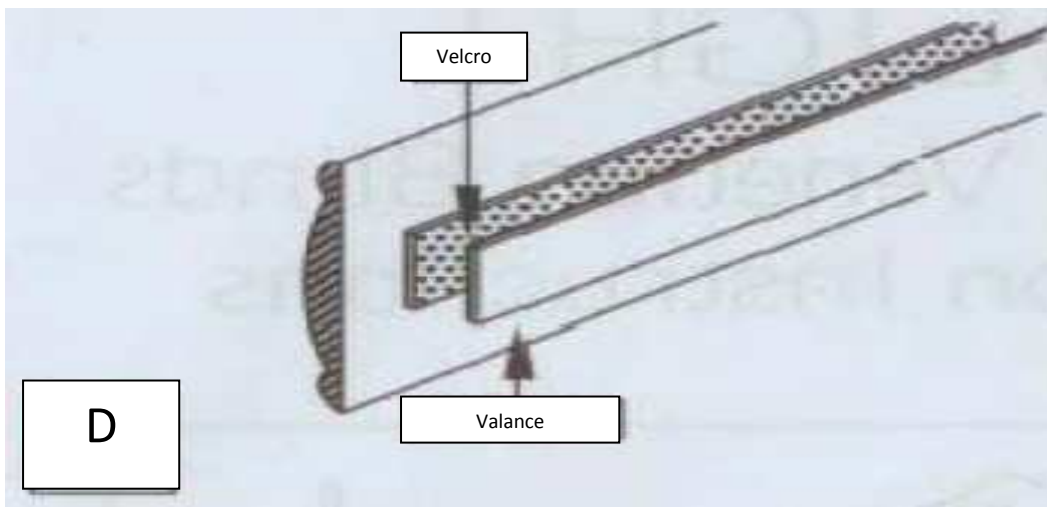

D. Stick the Velcro directly onto the head rail.

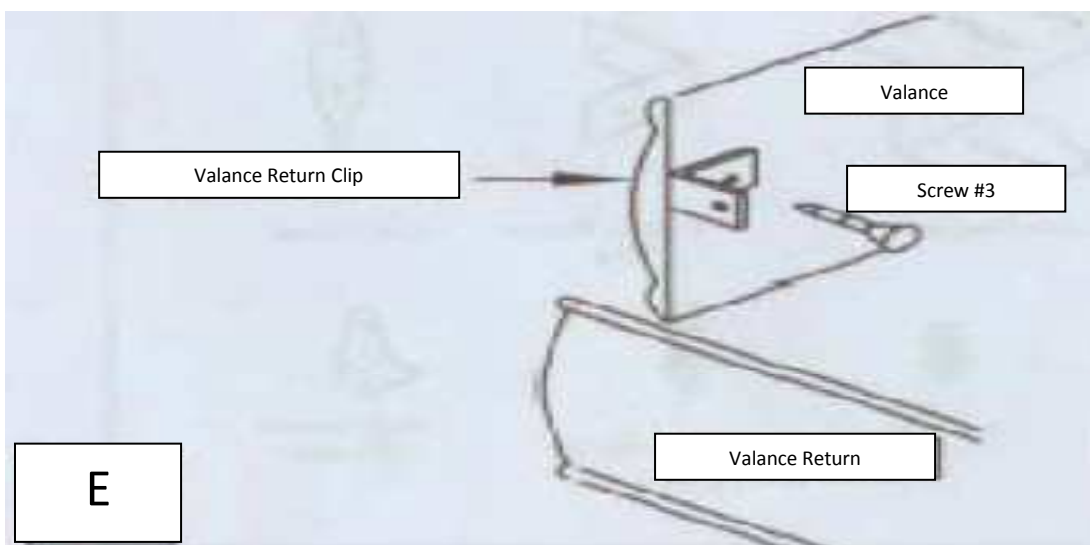

E. For Outside Mount: Screw one end of the valance using small Screw #3. Align the edge of the valance return the valance, screw the other end of the valance return clip onto the valance return.

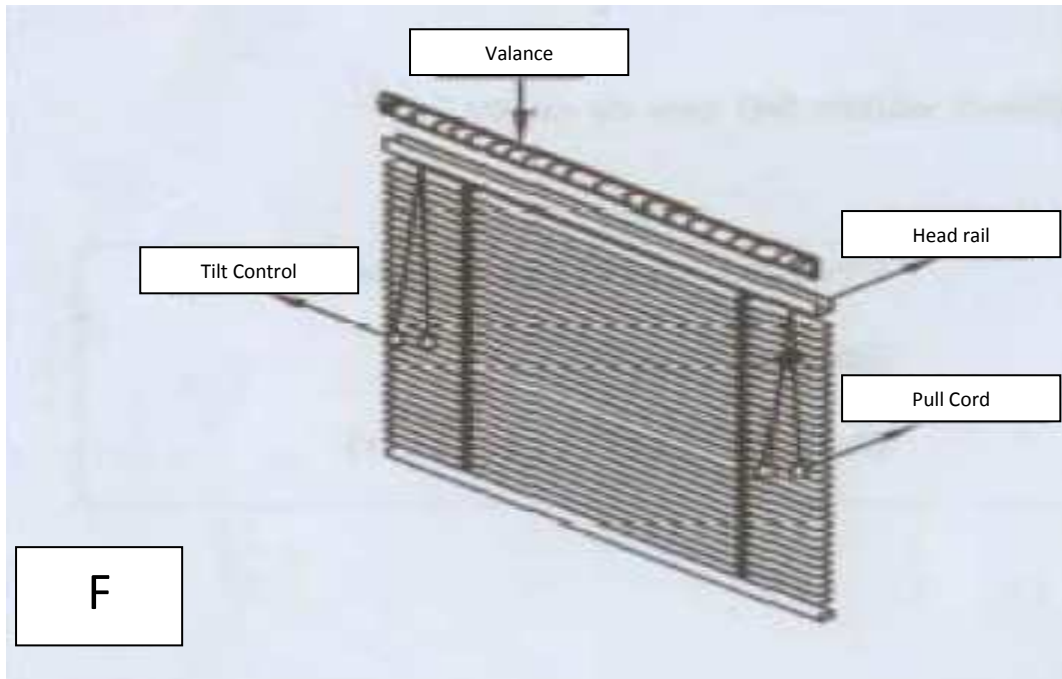

F. Push the valance to stick on top of the head rail. Always tilt blind horizontally before raising/lowering to extend the life of the blind. To lower blind: Move cord to left, pulling gently until cord lock releases. To raise blind: Pull cord downward until blind reaches desired height. To lock cords: Pull cord right and release. Cord will lock automatically.

Installing Holding Brackets (optional):

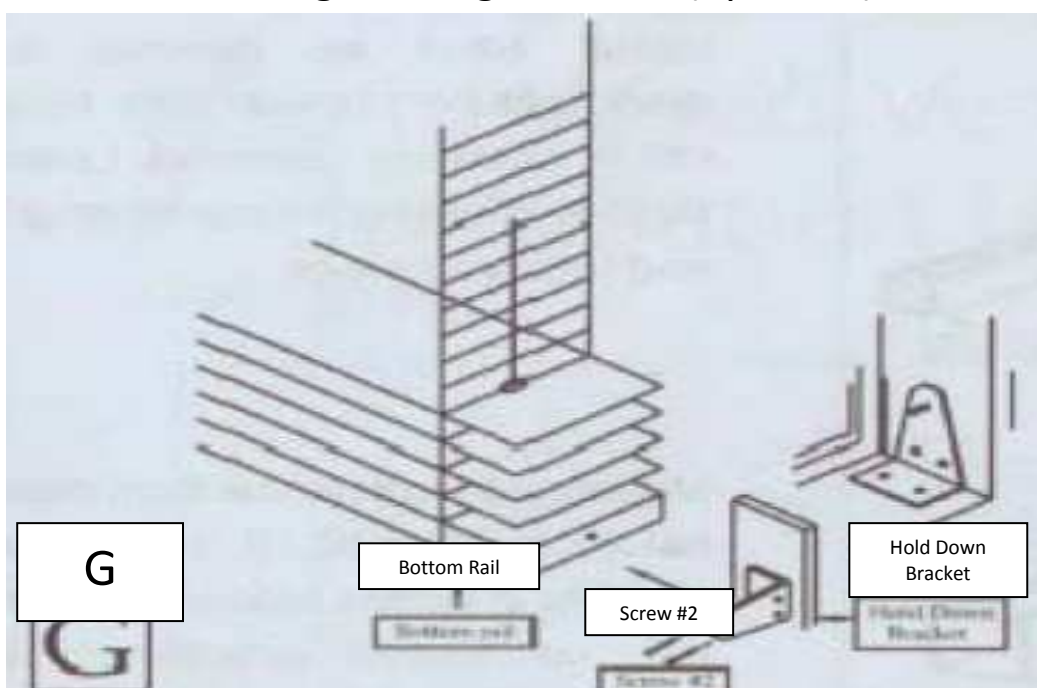

G. Hold down brackets: Using two small screws, screw hold down brackets to window facing or wall. Snap bracket pin ends into the hole at the bottom rail end.

**WARNING!**

Wood is a natural product and as such there might be slight variations in grain, colour and texture, and minor warpage may occur.

To protect the planet, we promise to plant 1 new tree in the place of the tree we cut down to produce this wooden blind.